



**SHOWER CUBICLE RANGE**

# SHOWER CUBICLE SELECTOR

Use this shower tray selector to choose the cubicle base size required.

## FRONT ENTRY 100MK2 SHOWER CUBICLE

### Standard doors

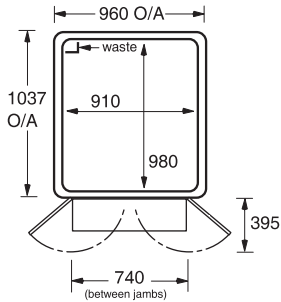

**Ramp size**  
950mm Width x 290mm Depth

### Bifold doors

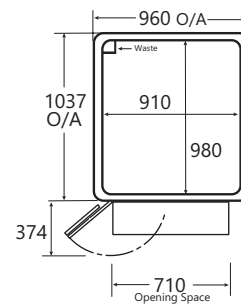

**Note:**  
Left hand bifold illustrated. Right hand version available.

## FRONT ENTRY SHOWER CUBICLE - MODEL101

### Standard doors

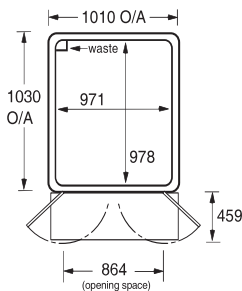

**Ramp size**  
1010mm Width x 430mm Depth

### Bifold doors

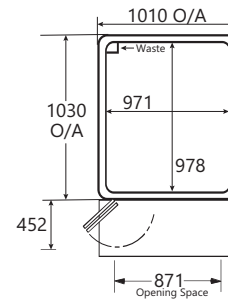

**Note:**  
Left hand bifold illustrated. Right hand version available.

## FRONT ENTRY SHOWER CUBICLE - MODEL120

### Standard doors

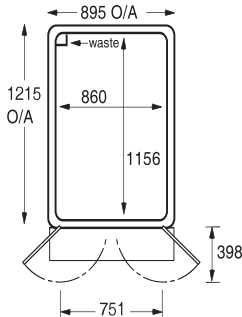

**Ramp size**  
890mm Width x 240mm Depth

### Bifold doors

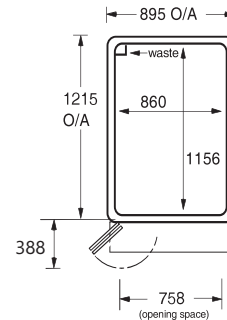

**Note:**  
Left hand bifold illustrated. Right hand version available.

## FRONT ENTRY SHOWER CUBICLE - MODEL120Plus

### Standard doors

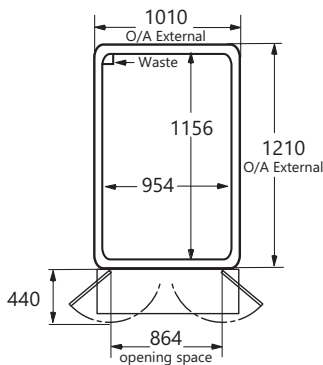

**Ramp size**  
1010mm Width x 470mm Depth

### Bifold doors

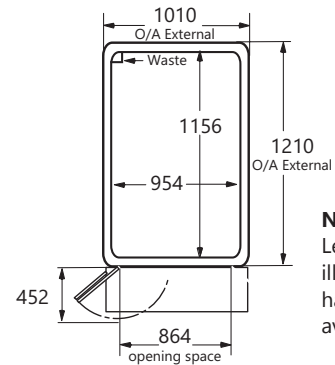

**Note:**  
Left hand bifold illustrated. Right hand version available.

### Notes:

1. Add 50mm at rear of cubicle to allow for waste hose - pumped waste version
2. Add 100mm to width to allow for shower unit services
3. Allow as much space as possible to gain access to services for routine maintenance

# SHOWER CUBICLE SELECTOR - SIDE ENTRY CUBICLES

Use this shower tray selector to choose the cubicle base size required.

## SIDE ENTRY MK2 SHOWER CUBICLE

### Standard doors

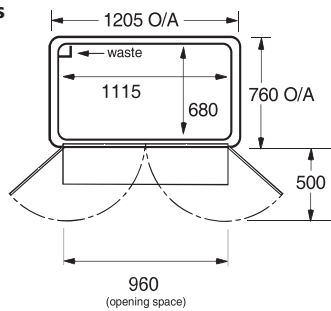

**Ramp size**  
1160mm Width x 250mm Depth

### Trifold doors

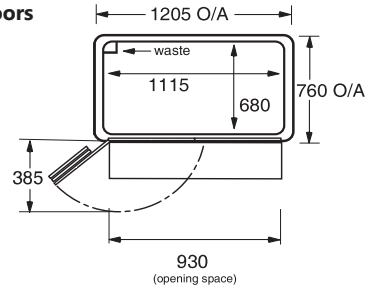

**Note:**  
Left hand trifold illustrated. Right hand version available.

### Notes:

1. Add 50mm at rear of cubicle to allow for waste hose - pumped waste version
2. Add 100mm to width to allow for shower unit services
3. Allow as much space as possible to gain access to services for routine maintenance

Shower cubicles are available with a large range of options and accessories, allowing the cubicle to be configured to suit specific client requirements. A quick order form is available to help select the appropriate options. If you would like to take advantage of our installation service please contact Customer Service on 01869 365500 opt 1 to arrange a visit by a Technical Sales Representative.



## SHOWER CHAIR CUBICLE COMPATIBILITY



Cubicle Model	Shower Chair Model											
	A02	A06	A08	A11	A13	A20	A21	TA18AP	TA18SP	TA21AP	TA21SP	TiS
100	✓	✓	✓	✗	✗	✓	✓	✓	✗	✓	✗	✗
101	✓	✓	✓	✗	✗	✓	✓	✓	✗	✓	✗	✗
120	✓	✓	✓*	✓	✗	✓	✓	✓	✓	✓	✗	✗
120Plus	✓	✓	✓	✓	✗	✓	✓	✓	✓	✓	✗	✓
Side Entry	✓	✗	✗	✗	✗	✓	✓	✗	✗	✗	✗	✗

\* 21" Model - standard door option only

TiS model cannot be tilted when in the cubicle

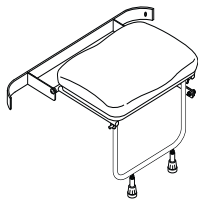

See pages 15-16 for shower seat compatibility

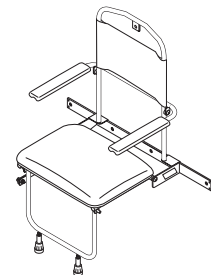



## HOW TO ORDER

### Cubicle kit contents:

- White shower tray with ramp
- Full height enclosure pack (half height carer assist panels available on request)
- Door set - half height or bifold doors
- Curtain Track and Hooks
- White Shower Curtain
- Grab rails
- Fitting instructions

### Extras

Shower seats shown on p15  
Shower unit shown on p25  
Macerator shown on p26

	Option 1	Option 2	Option 3
<b>Cubicle description</b>	<b>Half height door</b>	<b>Bifold (Left hand)</b>	<b>Bifold (Right hand)</b>
100MK2 Cubicle with pumped waste	Part no: SHCU100PW		
100MK2 with gravity waste	Part no: SHCU100G		

## Technical information

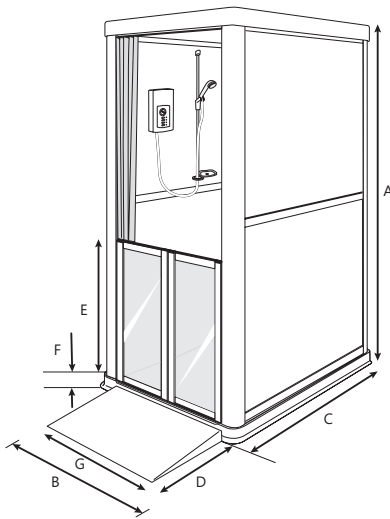

Ref	Dimensions
A	2030
B	950*
C	1037
D	280
E	810
F	50
G	950

\*Add 100mm if side controls fitted.

### Standard doors

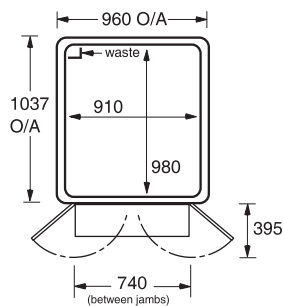

### Bifold doors

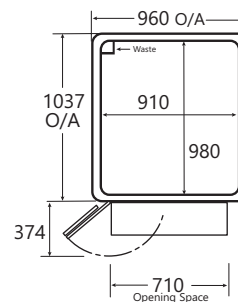

**Notes:** Dimensions are for doors fully open.

**Internal dimensions:** The width is measured from acrylic panel to acrylic panel. The depth is taken from the back acrylic panel to the inner face of the door.



### Shower chair compatibility

See page 9 for shower chair compatibility options





## HOW TO ORDER

Cubicle kit contents:

- White shower tray with ramp
- Full height enclosure pack (half height carer assist panels available on request)
- Door set - half height or bifold doors
- Curtain Track and Hooks
- White Shower Curtain
- Grab rails
- Fitting instructions

### Extras

Shower seats shown on p15  
Shower unit shown on p25  
Macerator shown on p26

	Option 1	Option 2	Option 3
<b>Cubicle description</b>	<b>Half height door</b>	<b>Bifold (Left hand)</b>	<b>Bifold (Right hand)</b>
101 Cubicle with pumped waste	Part no: SHCU101PW		
101 Cubicle with gravity waste	Part no: SHCU101G		

## Technical information

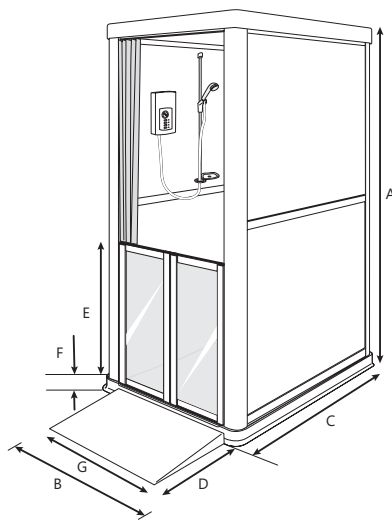

Ref	Dimensions
A	1900
B	1010*
C	1030
D	430
E	810
F	50
G	1010

\*Add 100mm if side controls fitted.

### Standard doors

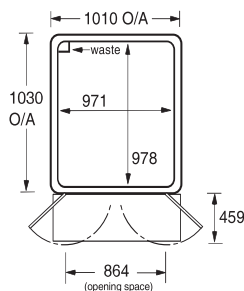

### Bifold doors

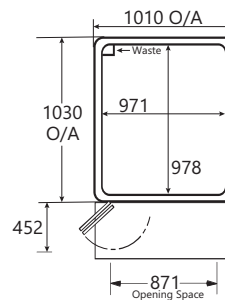

**Notes:** Dimensions are for doors fully open.

**Internal dimensions:** The width is measured from acrylic panel to acrylic panel. The depth is taken from the back acrylic panel to the inner face of the door.



### Shower chair compatibility

See page 9 for shower chair compatibility options





## HOW TO ORDER

### Cubicle kit contents:

- White shower tray with ramp
- Full height enclosure pack (half height carer assist panels available on request)
- Door set - half height or bifold doors
- Curtain Track and Hooks
- White Shower Curtain
- Grab rails
- Fitting instructions

### Extras

Shower seats shown on p15  
Shower unit shown on p25  
Macerator shown on p26

	Option 1	Option 2	Option 3
<b>Cubicle description</b>	<b>Half height door</b>	<b>Bifold (Left hand)</b>	<b>Bifold (Right hand)</b>
120 Cubicle with pumped waste	Part no: SHCU120PW		
120 Cubicle with gravity waste	Part no: SHCU120G		

## Technical information

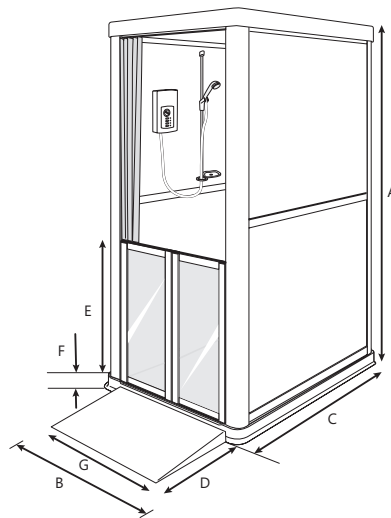

Ref	Dimensions
A	1900
B	890*
C	1215
D	240
E	810
F	50
G	890

\*Add100mm if side controls fitted.

### Standard doors

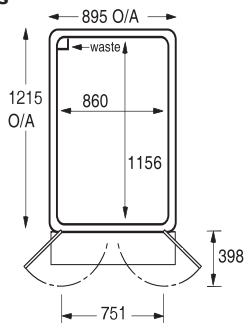

### Bifold doors

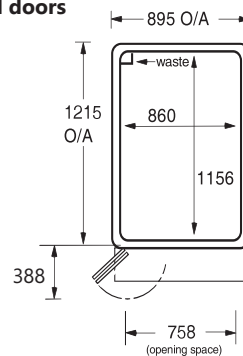

**Notes:** Dimensions are for doors fully open.

**Internal dimensions:** The width is measured from acrylic panel to acrylic panel. The depth is taken from the back acrylic panel to the inner face of the door.



### Shower chair compatibility

See page 9 for shower chair compatibility options





## HOW TO ORDER

### Cubicle kit contents:

- White shower tray with ramp
- Full height enclosure pack (half height carer assist panels available on request)
- Door set - half height or bifold doors
- Curtain Track and Hooks
- White Shower Curtain
- Grab rails
- Fitting instructions

### Extras

Shower seats shown on p15  
Shower unit shown on p25  
Macerator shown on p26

	Option 1	Option 2	Option 3
<b>Cubicle description</b>	<b>Half height door</b>	<b>Bifold (Left hand)</b>	<b>Bifold (Right hand)</b>
120Plus Cubicle with pumped waste	Part no: SHCU120PWPLUS		
120Plus Cubicle with gravity waste	Part no: SHCU120GPLUS		

## Technical information

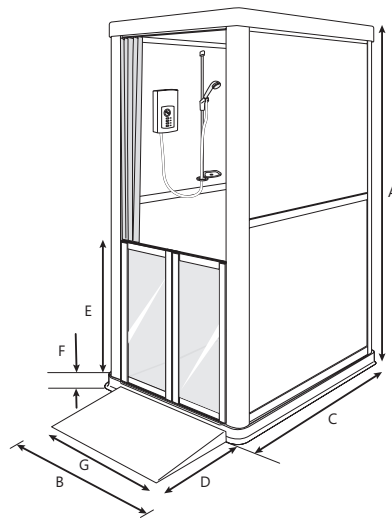

Ref	Dimensions
A	1900
B	1010*
C	1215
D	470
E	810
F	50
G	1010

\*Add100mm if side controls fitted.

### Standard doors

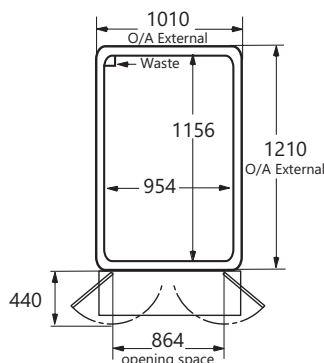

### Bifold doors

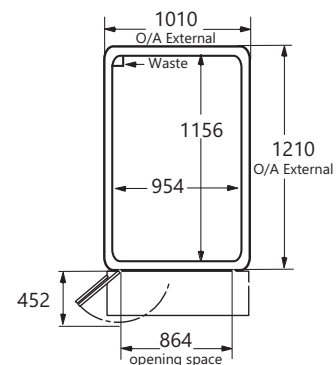

**Notes:** Dimensions are for doors fully open.

**Internal dimensions:** The width is measured from acrylic panel to acrylic panel. The depth is taken from the back acrylic panel to the inner face of the door.



### Shower chair compatibility

See page 9 for shower chair compatibility options





## HOW TO ORDER

Cubicle kit contents:

- White shower tray with ramp
- Full height enclosure pack (half height carer assist panels available on request)
- Door set - half height or bifold doors
- Curtain Track and Hooks
- White Shower Curtain
- Grab rails
- Fitting instructions

Extras

Shower seats shown on p15  
Shower unit shown on p25  
Macerator shown on p26

	Option 1	Option 2	Option 3
<b>Cubicle description</b>	Half height door	Bifold (Left hand)	Bifold (Right hand)
Side Entry Cubicle with pumped waste	Pt no: SHCUSEMK2PW		
Side Entry Cubicle with gravity waste	Pt no: SHCUSEMK2G		

## Technical information

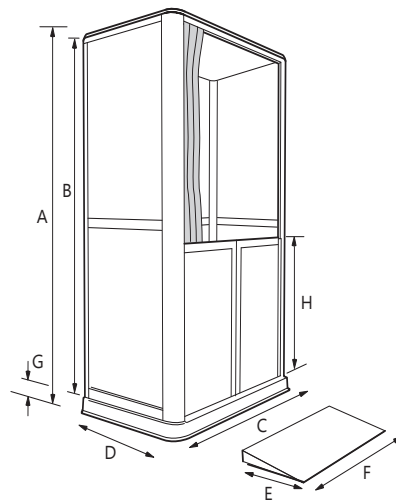

Ref	Dimensions
A	2030
B	1950
C	1160*+
D	760
E	250
F	1160
G	55
H	810

### Standard doors

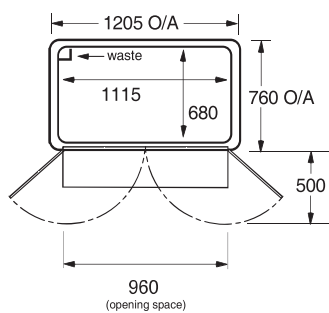

### Bifold doors

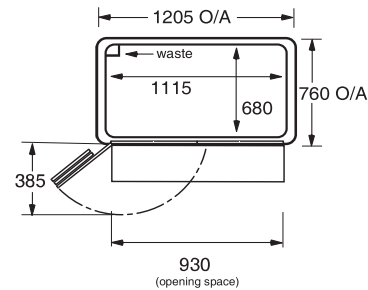

**Notes:** Dimensions are for doors fully open.

**Internal dimensions:** The width is measured from acrylic panel to acrylic panel. The depth is taken from the back acrylic panel to the inner face of the door.



### Shower chair compatibility

See page 9 for shower chair compatibility options





# CUBICLE SEATS

Shower seats for cubicles have a maximum load 127kg (20 stones) (279lb)

## SIDE ENTRY MK2

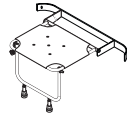
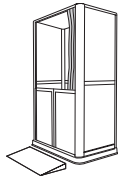

Tip-up PVC Shower Seat, with Adjustable Folding Support Legs  
code: SHSS4SEMK2

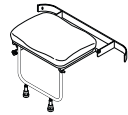

Tip-up Padded Seat, with adjustable folding support legs  
code: SHSS4PSEMK2

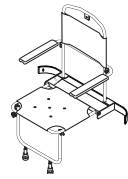

Tip-up PVC shower seat, with folding legs/ arms/ fixed backrest  
code: SHSS5SEMK2

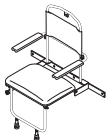

Tip-up shower seat, with flat padded seat with folding legs/arms, fixed backrest  
code: SHSS5PSE2FP

## FRONT ENTRY 100MK2

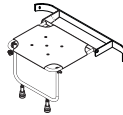

Tip-up PVC shower seat, with adjustable folding support legs  
code: SHSS4100

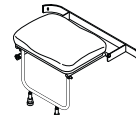

Tip-up Padded Seat, with adjustable folding support legs  
code: SHSS4P100

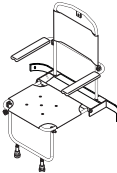

Tip-up PVC shower seat, with folding legs/arms/ fixed backrest  
code: SHSS5100

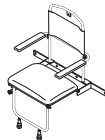

Tip-up shower seat, with flat padded seat with folding legs/arms, fixed backrest  
code: SHSS5P100

## FRONT ENTRY 101,120, 120plus

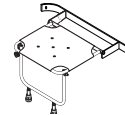
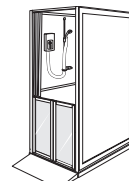

Tip-up PVC shower seat, with adjustable folding support legs  
code: SHSS475/ SHSS4101/SHSS4120

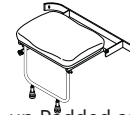

Tip-up Padded seat, with adjustable folding support legs  
code: SHSS4P75/ SHSS4P101/SHSS4P120

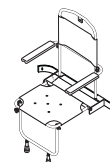

Tip-up PVC shower seat, with folding legs/arms, fixed backrest  
code: SHSS575/ SHSS5101/SHSS5120

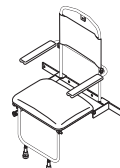

Tip-up shower seat, with flat padded seat with folding legs/arms/ fixed backrest  
code: SHSS5P75/ SHSS5P101/ SHSS5P120

## SIDE ENTRY MK1

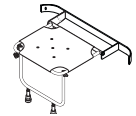
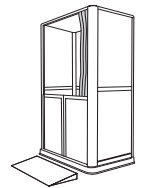

Tip-up PVC shower seat, with adjustable folding support legs  
code: SHSS4SE



Tip-up Padded seat, with adjustable folding support legs  
code: SHSS4PSE

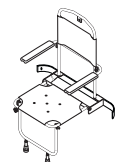

Tip-up PVC shower seat with folding legs/arms/ fixed backrest  
code: SHSS5SE

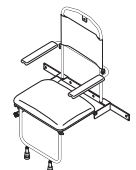

Tip-up shower seat, with flat padded seat with folding legs/arms/ fixed backrest  
code: SHSS5PS/E

# CUBICLE SEATS

## Shower Cubicle Seats - Information for ordering

Chiltern Invadex produce a wide range of seats for use with the Shower Cubicle range. Basic size information is shown below. Specialist seats can be made to order (extended delivery times apply).

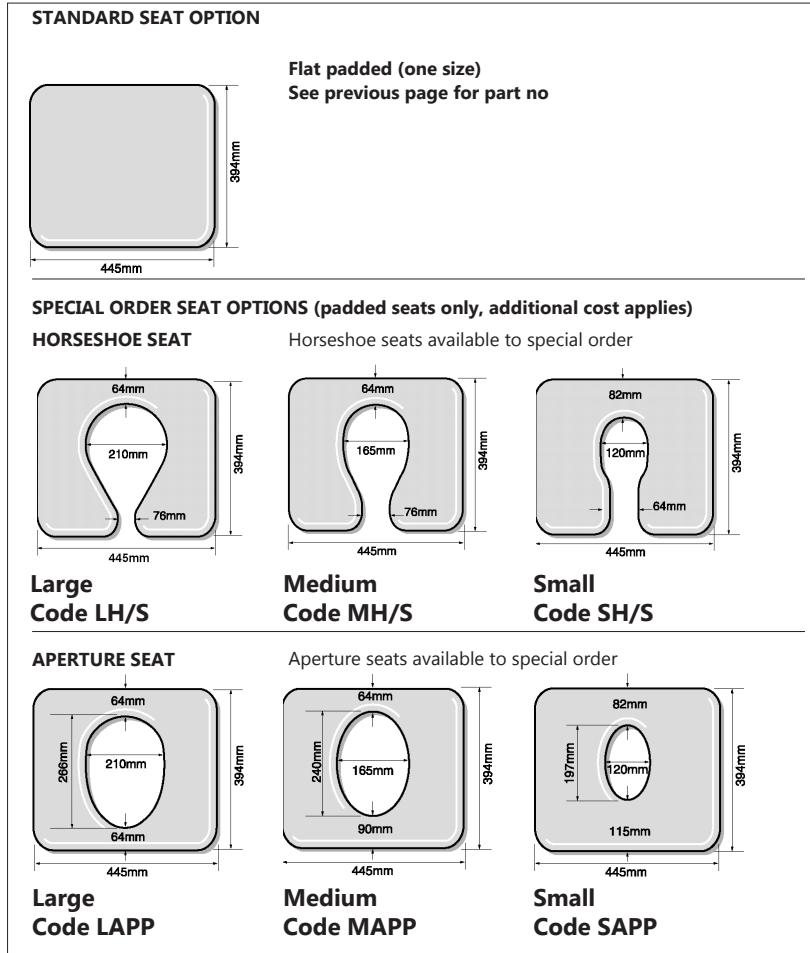



**SHOWER TOILET CUBICLE RANGE**

# SHOWER CUBICLE SELECTOR - FRONT ENTRY TOILET CUBICLES

Use this shower tray selector to choose the cubicle base size required.

## FRONT ENTRY 100MK2 SHOWER TOILET CUBICLE

**Standard doors**

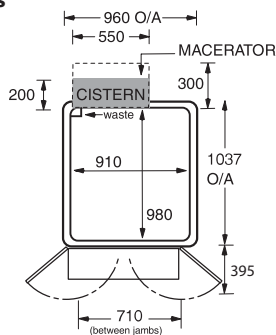

**Bifold doors**

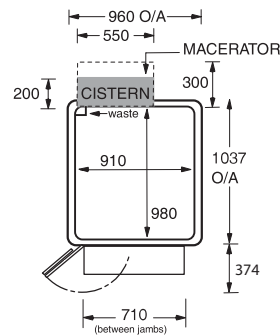

**Ramp size**  
950mm Width x 280mm Depth

**Note:**  
Left hand bifold illustrated. Right hand version available.

## FRONT ENTRY SHOWER TOILET CUBICLE - 101

**Standard doors**

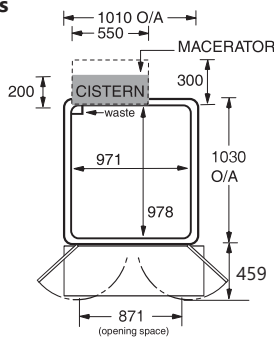

**Bifold doors**

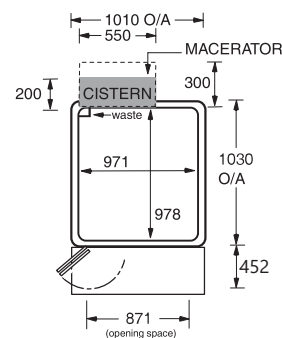

**Ramp size**  
1010mm Width x 430mm Depth

**Note:**  
Left hand bifold illustrated. Right hand version available.

## FRONT ENTRY SHOWER TOILET CUBICLE - 120

**Standard doors**

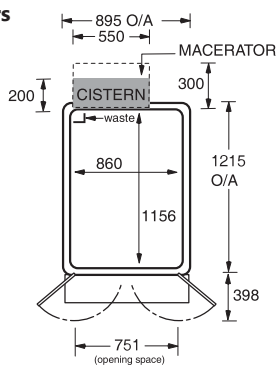

**Bifold doors**

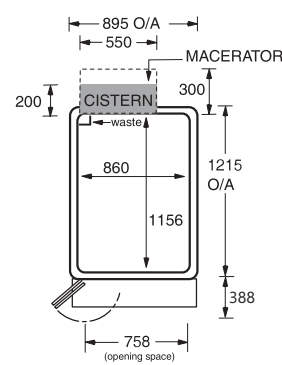

**Ramp size**  
890mm Width x 240mm Depth

**Note:**  
Left hand bifold illustrated. Right hand version available.

## FRONT ENTRY SHOWER TOILET CUBICLE - 120PLUS

**Standard doors**

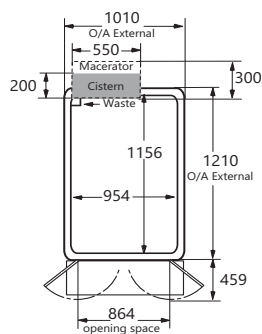

**Bifold doors**

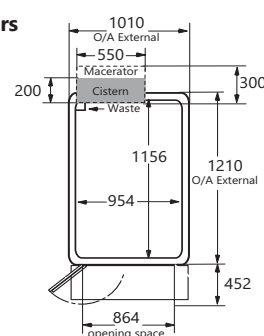

**Ramp size**  
1010mm Width x 470mm Depth

**Note:**  
Left hand bifold illustrated. Right hand version available.

# SHOWER CUBICLE SELECTOR - SIDE ENTRY TOILET CUBICLES

Use this shower tray selector to choose the cubicle base size required.

## SIDE ENTRY MK2 SHOWER TOILET CUBICLE

### Standard doors

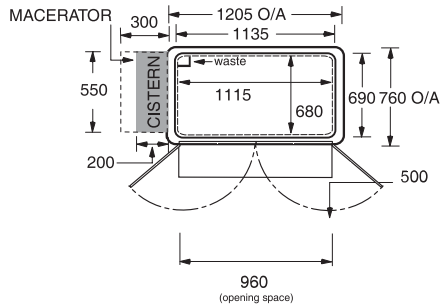

### Bifold doors

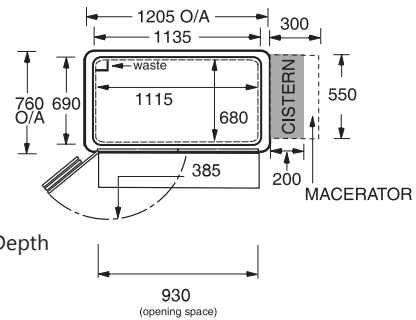

**Ramp size**  
1160mm Width x 250mm Depth

**Note:**  
Left hand bifold illustrated. Right hand version available.

- Notes:**
1. Add 50mm at rear of cubicle to allow for waste hose - pumped waste
  2. Add 100mm to width to allow for shower unit services
  3. Allow as much space as possible to gain access to services for routine maintenance.



## SHOWER CHAIR CUBICLE TOILET COMPATIBILITY



Cubicle Model	Shower Chair Model											
	A02	A06	A08	A11	A13	A20	A21	TA18AP	TA18SP	TA21AP	TA21SP	TiS
100	✓	✓	✓	✗	✗	✗	✗	✓	✗	✓	✗	✗
101	✓	✓	✓	✗	✗	✗	✗	✓	✗	✓	✗	✗
120	✓	✓	✓*	✓	✗	✗	✗	✓	✓	✓	✗	✗
120Plus	✓	✓	✓	✓	✗	✗	✗	✓	✓	✓	✗	✓
Side Entry	✓	✗	✗	✗	✗	✗	✗	✗	✗	✗	✗	✗

\* 21" Model - standard door option only  
TiS model cannot be tilted when in the cubicle





## HOW TO ORDER

### Cubicle kit contents:

- White shower tray with ramp
- Full height enclosure pack (half height carer assist panels available on request)
- WC pan and cistern
- Plastic basin (fillable via shower hose)
- Door set - half height or bifold doors
- Curtain track, hooks & white shower curtain
- 2x Grab rails
- Fitting instructions

### Extras

Ceramic basin & lever taps shown on p25  
Shower unit shown on p25  
Macerator shown on p26

	Option 1	Option 2	Option 3
<b>Cubicle description</b>	<b>Half height door</b>	<b>Bifold (Left hand)</b>	<b>Bifold (Right hand)</b>
100MK2 Cubicle Toilet with pumped waste	Part no: SHTCU100PW		
100MK2 Cubicle Toilet with gravity waste	Part no: SHTCU100G		

## Technical information

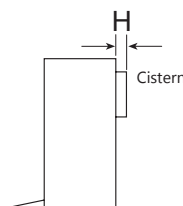
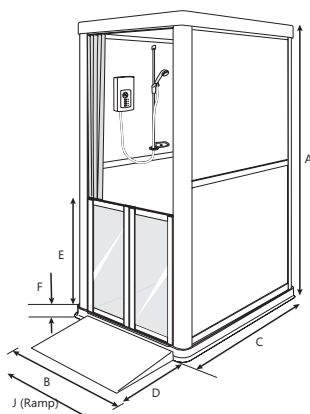

Ref	Dimensions
A	2030
B	950*+
C	1037
D	280
E	810
F	50
H	200
J	950

\*Add 100mm if side controls fitted.  
+Add 75mm if basin fitted.

### Standard doors

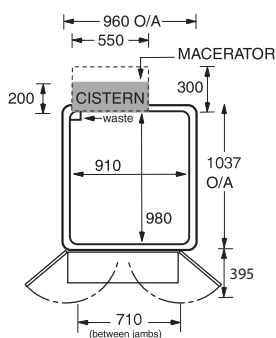

### Bifold doors

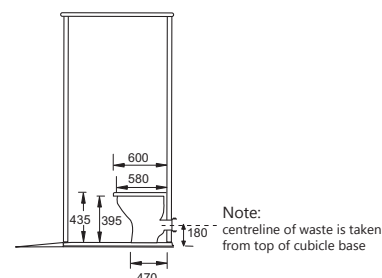
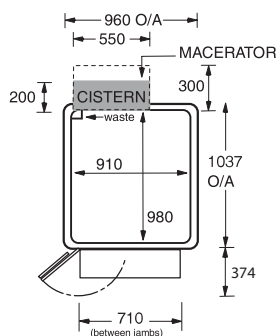

**Notes:** Dimensions are for doors fully open.

**Internal dimensions:** The width is measured from acrylic panel to acrylic panel. The depth is taken from the back acrylic panel to the inner face of the door.



### Shower chair compatibility

See page 19 for shower chair compatibility options





## HOW TO ORDER

### Cubicle kit contents:

- White shower tray with ramp
- Full height enclosure pack (half height carer assist panels available on request)
- WC pan and cistern
- Plastic basin (fillable via shower hose)
- Door set - half height or bifold doors
- Curtain track, hooks & white shower curtain
- 2x Grab rails
- Fitting instructions

### Extras

- Ceramic basin & lever taps shown on p25
- Shower unit shown on p25
- Macerator shown on p26

	Option 1	Option 2	Option 3
<b>Cubicle description</b>	<b>Half height door</b>	<b>Bifold (Left hand)</b>	<b>Bifold (Right hand)</b>
101 Cubicle Toilet with pumped waste	Part no: SHTCU101PW		
101 Cubicle Toilet with gravity waste	Part no: SHTCU101G		

## Technical information

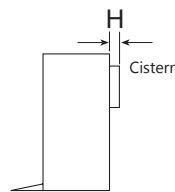
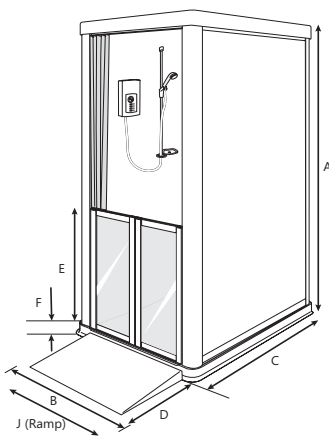

Ref	Dimensions
A	1900
B	1010*+
C	1030
D	430
E	810
F	50
H	200
J	1010

\*Add 100mm if side controls fitted.  
+Add 75mm if basin fitted.

### Standard doors

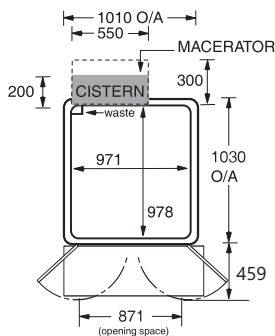

### Bifold doors

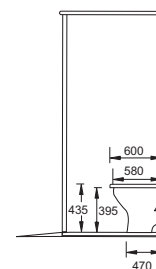
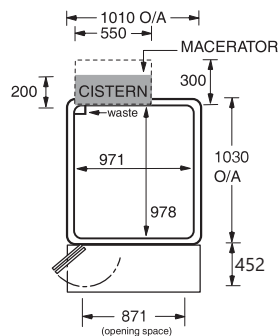

Note: centreline of waste is taken from top of cubicle base

**Notes:** Dimensions are for doors fully open.

**Internal dimensions:** The width is measured from acrylic panel to acrylic panel. The depth is taken from the back acrylic panel to the inner face of the door.



### Shower chair compatibility

See page 19 for shower chair compatibility options





## HOW TO ORDER

### Cubicle kit contents:

- White shower tray with ramp
- Full height enclosure pack (half height carer assist panels available on request)
- WC pan and cistern
- Plastic basin (fillable via shower hose)
- Door set - half height or bifold doors
- Curtain track, hooks & white shower curtain
- 2x Grab rails
- Fitting instructions

### Extras

Ceramic basin & lever taps shown on p25  
Shower unit shown on p25  
Macerator shown on p26

	Option 1	Option 2	Option 3
<b>Cubicle description</b>	<b>Half height door</b>	<b>Bifold (Left hand)</b>	<b>Bifold (Right hand)</b>
120 Cubicle Toilet with pumped waste	Part no: SHTCU120PW		
120 Cubicle Toilet with gravity waste	Part no: SHTCU120G		

## Technical information

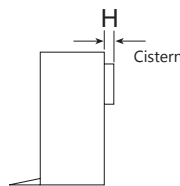
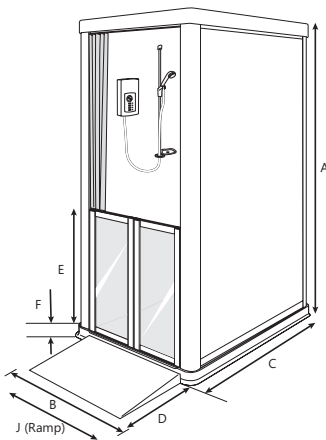

Ref	Dimensions
A	1900
B	890*+
C	1215
D	240
E	810
F	50
H	200
J	890

### Notes:

\*Add 100mm if side controls fitted.  
+Add 75mm if basin fitted.

### Standard doors

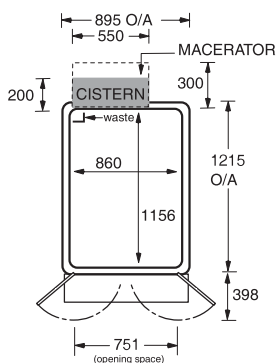

### Bifold doors

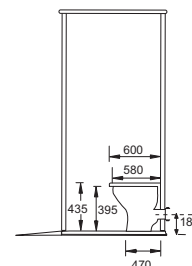
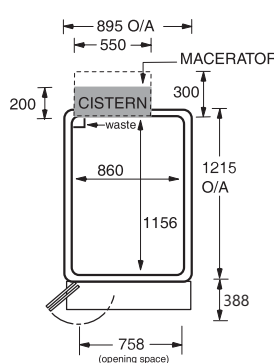

Note: centreline of waste is taken from top of cubicle base

**Notes:** Dimensions are for doors fully open.

**Internal dimensions:** The width is measured from acrylic panel to acrylic panel. The depth is taken from the back acrylic panel to the inner face of the door.



### Shower chair compatibility

See page 19 for shower chair compatibility options







## HOW TO ORDER

Cubicle kit contents:

- White shower tray with ramp
- Full height enclosure pack (half height carer assist panels available on request)
- WC pan and cistern
- Plastic basin (fillable via shower hose)
- Door set - half height or bifold doors
- Curtain track, hooks & white shower curtain
- 2x Grab rails
- Fitting instructions

### Extras

Ceramic basin & lever taps shown on p25  
Shower unit shown on p25  
Macerator shown on p26

	Option 1	Option 2	Option 3
<b>Cubicle description</b>	<b>Half height door</b>	<b>Bifold (Left hand)</b>	<b>Bifold (Right hand)</b>
120Plus Cubicle Toilet with pumped waste	Part no: SHTCU120PWPLUS		
120Plus Cubicle Toilet with gravity waste	Part no: SHTCU120GPLUS		

## Technical information

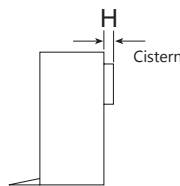
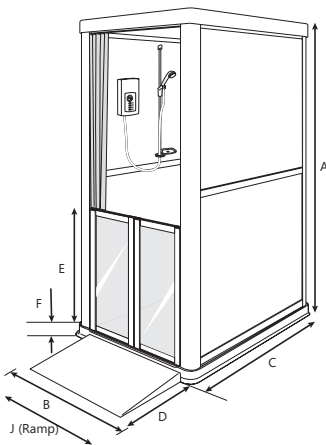

Ref	Dimensions
A	1900
B	1010
C	1215
D	470
E	810
F	50
H	200
J	1010

### Notes:

\*Add 100mm if side controls fitted.  
+Add 75mm if basin fitted.

### Standard doors

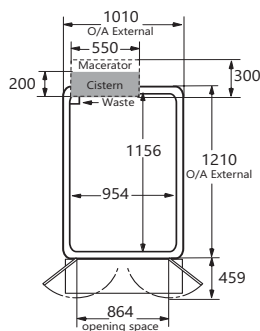

### Bifold doors

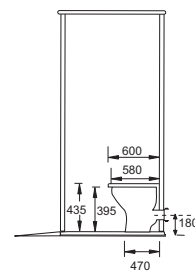
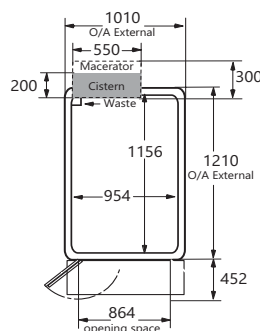

Note: centreline of waste is taken from top of cubicle base

**Notes:** Dimensions are for doors fully open.

**Internal dimensions:** The width is measured from acrylic panel to acrylic panel. The depth is taken from the back acrylic panel to the inner face of the door.



### Shower chair compatibility

See page 19 for shower chair compatibility options





## HOW TO ORDER

Cubicle kit contents:

- White shower tray with ramp
- Full height enclosure pack (half height carer assist panels available on request)
- WC pan and cistern
- Plastic basin (fillable via shower hose)
- Door set - half height or bifold doors
- Curtain track, hooks & white shower curtain
- 2x Grab rails
- Fitting instructions

### Extras

Ceramic basin & lever taps shown on p25  
Shower unit shown on p25  
Macerator shown on p26

	Option 1	Option 2	Option 3
<b>Cubicle description</b>	<b>Half height door</b>	<b>Bifold (Left hand)</b>	<b>Bifold (Right hand)</b>
Side Entry MK2 Cubicle with pumped waste	Part no: SHTCUSE2PW		
Side Entry MK2 Cubicle with gravity waste	Part no: SHTCUSE2G		

## Technical information

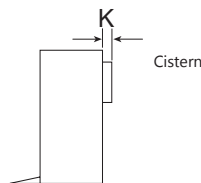
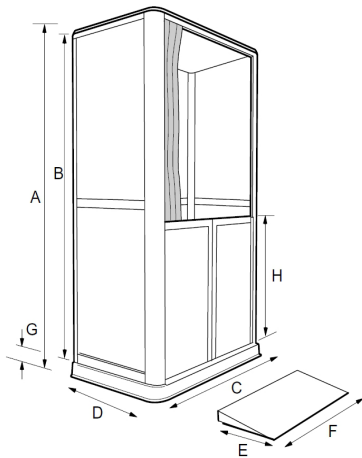

Ref	Dimensions
A	2030
B	1950
C	1160*+
D	740
E	250
F	1160
H	810
K	200

### Notes:

\*Add 100mm if side controls fitted.  
+Add 75mm if basin fitted.

### Standard doors

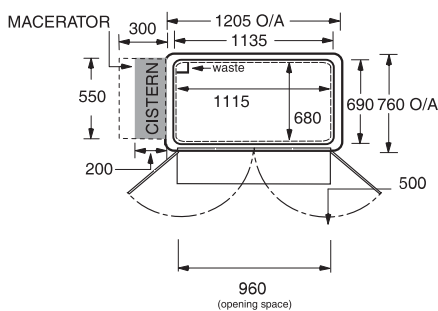

### Bifold doors

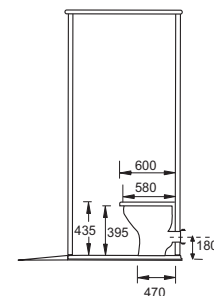
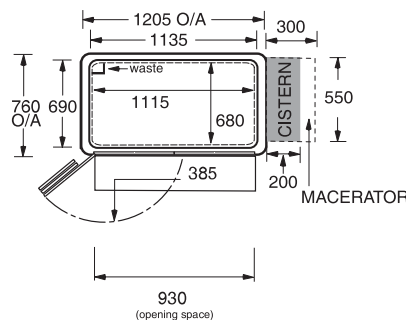

Note: centreline of waste is taken from top of cubicle base

**Notes:** Dimensions are for doors fully open.

**Internal dimensions:** The width is measured from acrylic panel to acrylic panel. The depth is taken from the back acrylic panel to the inner face of the door.



Shower chair compatibility  
See page 19 for shower chair compatibility



## CUBICLE EXTRAS



Ceramic basin and lever taps are available as an alternative to the standard plastic basin.

This option must be specified at time of order to enable reinforcement of the side panel.

Cannot be retro-fitted

code	product
SHSU029	Ceramic cubicle basin & lever taps



### Mira Advance ATL Flex Extra Electric Shower

- Mira Advance ATL Flex 9kW electric shower offers a flexible solution for those who are looking for safety and increased mobility within the showering area
- Extended temperature control lever, 2m hose and additional handset holder for flexible showering heights.
- Compatible with the Whale Instant Match Pump see page 39
- 2 Year guarantee

code	product
IDWMA05A	Mira Advance ATL Flex - Electric 9 Kw shower heater, incl. 1 metre riser rail and 2 metre hose, separate wall mounted handset holder, standard riser rail, and easy touch temperature control lever



### Mira Excel Thermostatic Mixer shower

- Showering with precise thermostatic control, recognising and compensating for changes in water temperature to provide an extremely safe and satisfying shower
- Easy installation features save time and installation costs
- Includes maximum temperature stop for safe showering
- 5 year guarantee

code	product
IDWME01A	Mira Excel - Thermostatic Mixing Valve (handset, riser rail and hose included)



# SANITARY SYSTEMS



## Saniplus small bore sanitary system

- Breaks down toilet waste from a shower, wash basin or W.C for pumping away through a small bore (22mm) pipe
- A powerful motor enables the unit to pump the waste and water up to 5m vertically, 100m horizontally or a lesser combination of both, where conventional large bore pipework is impractical
- Features a new case with sound reduction and integrated carbon filter
- Can be used with Whale pump option

code	product
SH0411	Saniplus sanitary system

## Technical information

- Motor induction motor (no carbon brushes or gears to wear out). Tested over 30,000 cycles.
- Watts (Consumption) 400w
- Electrical Supply 220-240V 50Hz
- Flow rate at max head l/min 40 Horizontal Discharge 100 metres
- Vertical Discharge 5 metres
- Gravity fall on horizontal installations 1:100
- Discharge Pipe Diameter 22mm
- Materials Polypropylene, C.R.P., stainless steel, Neoprene Type of WC Pan (not included)
- Short spigot 100mm HO outlet (BS EN 33/37) Motor RPM 2800 RPM
- Normal Running Time WC 10-20 secs approx or as required, to discharge bath, shower etc
- Dimensions (vertical height is measured from floor level) 512W x 305 O/H x 200D (requires 210mm behind spigot)

Designed to fit BS EN 33/37 WC pans.

As close coupled cistern dimensions vary, it may be necessary, with certain designs, to utilise a spacer between cistern and wall

## Saniplus small bore sanitary system (shown with Whale pump option)

### Saniplus small bore sanitary system with Whale pump

Where the situation demands, or if the pipe run is greater than that specified for the Whale pump a Saniplus small bore sanitary system may be used. The discharge from the Whale pump must go into the top of the Saniplus small bore sanitary system.

**Do not use the bottom entries.**

It is preferable to have two separate discharge lines to waste and drainage when used in the same room as a Saniplus small bore sanitary system. Any failure of the Saniplus small bore sanitary system will not be detected by the Whale pump.

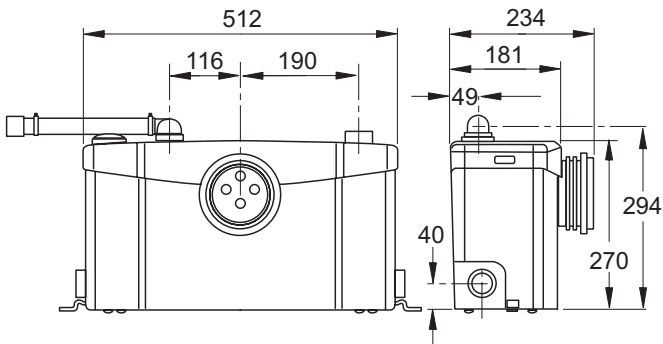

## Pumping distance illustration

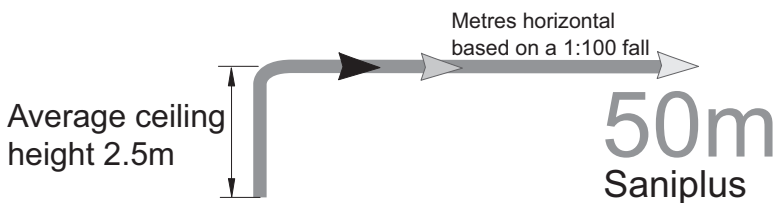

NB: Vertical lift must precede horizontal run

Note: If you increase 'horizontal' pipe fall to full 1:40 gravity fall, then the horizontal distance can be increased to virtually any distance required (also increase pipe size)

Macerator shown in relation to a Chiltern Invadex Shower toilet cubicle

